

PMA KS 98-2

Multi-function unit

Overview

Our multi-function unit KS98-2 combines PID control, process monitoring, sequence control, data logging and alarm system. The modular design allows to compose the hardware to exactly fit to a specific application. Application programs can be created and maintained by easily selecting and connecting function blocks graphically using the "KS98-ET"-utility. This method is ideal for creating individually customized solutions, including all user interface pages with minimal effort. As a complete solution in a single unit, the KS98-2 multi-function unit helps to reduce programming, installation cost and control cabinet space.

Our library of function blocks is offering well established solutions like:



Key features

- Controllers with self-tuning, auto/manual, parameter-set and setpoint selection and limitation functions.
Operation and monitoring of cascaded control loops.
- Modular programmer with recipe selection in plain text, auto/manual operation, manual or automatic search, master/slave tracks, etc.
- An alarm system that clearly lists events and their acknowledgement in the sequence of occurrence.
- Trend displays with zoom function to monitor relevant process values.
- Bargraph displays with indication min/max limit settings
- Datalogger functions to record process values and events over time
- Clock functions
- Transparent operating dialogues individually adapted to the process and user requirements.
- Avoidance of unwanted operation by access rights and situation-related (password, control signals).
- Event-driven switchover of display color to notify operators about special conditions.

SYSTEM DESCRIPTION

Concept

KS98-2 is a compact versatile automation system in a DIN-controller form factor. It allows flexible adaption of its in- and outputs to the needs of the application. It is an awesome base for an automation solution that is optimized by means of functionality, reliability, size and cost.

The hardware of KS98-2 is specifically designed to deal with analog variables in the process industry. Additional signal transmitters and the associated costs for installation can be omitted, as most sensors are directly supported, and galvanic isolations are present as well.

The front control panel with 3,5" color-display offers transparent data representation and clear structured menus. For an intuitive operation the unit offers a combination of dedicated buttons and touch-screen.

To create application programs KS98-2 provides an easy to use graphical engineering-tool with embedded process simulation. The function-block editor allows to compile, test and optimize an application project by using a library of sophisticated control functions.

Established control function blocks with integrated self-tuning based on years long experience are the fundament to quickly achieve the desired control performance even in complex applications.

The USB front interface provides all time access to the unit with a PC. This supports fast check and adjustment of parameters and helps to identify problems in advance.

Whether you need a compact standalone solution or a sophisticated control sub-system in a wider infrastructure KS98-2 will do the job for you with low risk and investment.

Hardware Flexibility

KS98-2 offers a comprehensive modularity of in- and outputs.

Basic configuration

Each base unit is at least equipped with the following in- and outputs:

- One universal input supporting direct connection of various sensors and standard signals.
- A transmitter supply TPS.
- Two digital control inputs for 24V logic signals.

- 2 or 4 relay outputs.

Internal I/O-Extension

To individually expand the unit to fit the application plug-in I/O-modules are available.

Each basic version of KS 98-2 provides 2 module slots with connections at terminal A and if equipped with 2 relays 2 more with connections at terminal P.

In addition, option module carrier boards with 4 slots each can be installed behind terminals B and C. Alternatively digital in-output-boards (10DI, 4DO) can be installed.

Each plug-in I/O-module provides one or two in- / output channels.

Option modules can be ordered ready installed with a KS98-2 unit or as a separate accessory. Installation at a later state is always possible without the need of calibration.



Option modules

Analog Inputs

- U: 1x Universal Input
- R: 2x Resistive Measurements
- T: 2x Thermocouples, mV, mA
- V: 2x Voltage ($R_{in} \gg 1G\Omega$)
- P: 1x 0/4...20mA with Transmitter Power Supply

Analog Outputs

- L: 2x Linear Output 0/4...20mA
- B: 2x Bipolar Output -10V...10V, 0/2...10V

Digital-In-/Outputs

- D: 2x 24V Digital I/O
- A: 2x SSR Driver

Both channels of the D-Module can be configured separately for input or output usage. Signal state can be reversed.

Remote I/O Extension

The onboard CANopen Interface allows to KS98-2

extend the I/O of the multifunction unit KS 98-2 even more with additional Remote-I/O.

- Dedicated function blocks allow to easily integrate prepared in-/output components (i.e. RM200)
- Cross communication to other KS98-2 or KS 98-1 systems is also prepared for easy usage.
- Other CANopen conformal components can be connected by using basic communication blocks.

Depending on the system structure, the number of nodes, the amount of data and the selected transmission speed refresh times will vary. It needs to be checked that the setup fulfills the requirements of the application.

A detailed description of the communication functions is provided in the KS 98-2 full manual.

Details of I/O-systems can be found in the related data sheets.

Function Block Library

The Function block library offers a variety of practice-proven building bricks from the following areas

- scaling, linearization and calculation
- monitoring and alarming
- process and logic control
- operation and visualization
- recording

To create application programs, the blocks can be selected and interconnected with the graphical engineering tool ET/KS98-2.

The tool automatically monitors the use of program memory and execution time.

User Interface

The 3,5" color display provides clearly arranged operator screens for the various library functions. They become available as soon a library function is used in the application program. Furthermore, everything necessary for configuration and parametrization of the functions can be accessed from the KS 98-2 front interface. For commissioning and maintenance, a technician can also access the in- and output data of all function blocks.

Operator pages

Ready screens for controllers, cascaded controllers, profilers, bargraph displays, trend monitoring as well as alarm- and event-lists are available with the related function blocks.

Operator screens can be selected via the

menu or can be opened with direct reference from other pages or can be opened triggered by events.

The display function block VWERT allows to compose own application-oriented screens.

With help from the VPARA function block lists of selected parameters can be compiled.

Complete application designed user screens can be created with the VUSER block and its sub-elements.

Operator screens can be locked or hidden by the user program logic.

Access control

KS98-2 provides several possibilities to lock operation, parametrization or configuration. With this tools planners are able to create the right access control for their application.

Locked can be the complete operator interface, just parameters or configurations or even single functions.

Communication

Each KS98-2 provides a front accessible USB Device Interface. This interface is designed primarily to be used for programming and diagnosis.

The standard communication option provides Ethernet. Process data and parameters are accessible via Modbus-TCP.

Ftp can be used to upload logger files.

Additional option modules can be installed to support industrial field bus communication like Modbus-RTU, ProfibusDP or ProfiNet.

The amount and type of data KS98-2 provides to the outside world can be defined in the user program.

Engineering Tools

Engineering Tool ET/KS98-2

The Engineering Tool ET/ KS 98-2 is a graphical function-block editor supporting programming, commissioning and diagnosis.

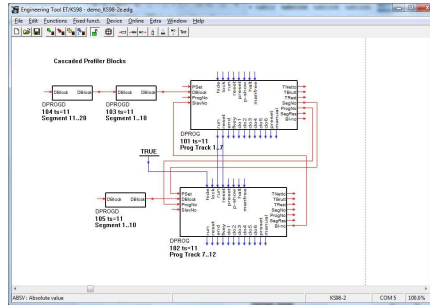

Its main functions are:

- Selection of function-blocks from a library and placing them in the workspace
- Application specific graphical connection of in- and output signals
- Configuration and parametrization of Functions-blocks via context menus
- Download of user programs into the unit
- Upload of user programs from devices (can be protected via password)
- Recipe creation and administration

Communication to the unit is possible via Front-USB connector or Ethernet.

Simulation SIM/KS98-2

The PC-Simulation allows to fully test a KS 98-2 user program regarding functionality and user interface without a real device. Input signals can be stimulated and resulting output values can be monitored.

Pre-testing and fine-tuning of functionality and user dialogs can be performed at an early stage of a project.

The SIM/KS98-2 utility embeds a process simulation with adjustable dynamic behavior. With it, the control performance can be evaluated even before commissioning.

Additional Functions: Trend display, Online-monitoring and Turbo-mode simulation.

Utility OEM/KS98-2

The OEM tool is used to individualize the KS98-2 user interface. Using company-logos and individual color selections the appearance of KS98-2 screens can be adopted to customers design specifications. In addition, individualized icons in the status bar can often be used to achieve clearer signaling for specific applications.

The OEM-Tool furthermore supports downloading images used to create user specific screens.

Evaluation software LOG/KS98-2

This software supports the KS98-2 datalogger functionality. The utility can

upload logged data files via ftp and display the content.

The values displayed as trend graphics can be analyzed in detail by enlarging sections and by using a cursor.

Downloader DL/KS98-2

This utility allows to download a packed user program without the possibility to see the code. It supports field updates of user programs.

BlueFlasher

This utility is to update the Firmware of devices in the field. That way older devices can benefit from new features or performance enhancements developed after they have been manufactured.

TECHNICAL DATA

In-/Outputs Base Unit

Arrangement of In- and Outputs

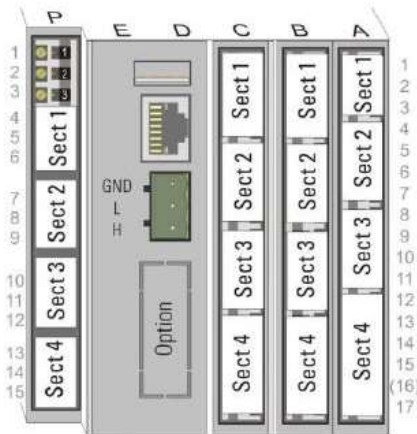

Analog Inputs

Universal Input (Terminal A, Sect. 4)

Resolution: 16bit
Measurement cycle: 100ms

Thermocouples

According to DIN IEC 584

Typ e	Range	Error	Resolution
L ¹⁾	-200...900°C	≤ 2K	0,05 K
J ¹⁾	-200...1200°C	≤ 2K	0,05 K
K ¹⁾	-200...1350°C	≤ 2K	0,072 K
N ¹⁾	-200...1300°C	≤ 2K	0,08 K
S	-50...1760°C	≤ 3K	0,275 K
R	-50...1760°C	≤ 3K	0,244 K
B ²⁾	0...1820°C	≤ 3K	0,132 K
T ¹⁾	-200...400°C	≤ 2K	0,056 K
C ³⁾	0...2300°C	≤ 2K	0,18 K
E ¹⁾	-200...900°C	≤ 2K	0,038 K

¹⁾ accuracy valid from -100 °C

²⁾ accuracy valid from 400 °C

³⁾ C(W) W5Re/W26Re

Temperature linear in °C or °F

Input resistance: ≥ 1 MΩ

Cold junction compensation

internal/external

Sensor monitoring:

Current through sensor ≤ 1 μA

Reverse polarity detection triggered at 30 °C below start of range. Sensor status

information is available to be used in the

application program.

Influence of internal CJC

≤ 0,5 K per 10 K terminal temperature

External CJC

selectable: 0...60 °C or. 32...140 °F

Resistance thermometer

Pt 100 DIN IEC 751 and

Temperature difference 2x Pt 100

Range	Error	Resolution
-200,0...250,0 °C	≤ 0.5K	0,024 K
-200,0...850,0 °C	≤ 1.0K	0,05 K

Linearization for °C or °F

3-wire connection

Lead resistance ≤ 30 Ω per lead

Sensor current ≤ 1 mA

Input circuit monitoring for sensor/lead break and short circuit

Potentiometers

Range	Error	Resolution
0...500 Ω ¹⁾	≤ 0.1 %	≤ 0.02Ω

¹⁾ Rtotal incl. 2 x RL

Resistance linear

Sensor current ≤ 1 mA

Adjustment/scaling with sensor connected.

Input circuit monitoring for sensor/lead break and short circuit

Resistance measurement

Range	Error	Resolution
0...250 Ω	≤ 0.25Ω	≤ 0.01Ω
0...500 Ω	≤ 0.5Ω	≤ 0.02Ω

Direct current 0/4...20 mA

Range	Error	Resolution
0/4...20 mA	≤ 0.1 %	≤ 0.8μA

Input resistance: 5 Ω

Input circuit monitoring 4...20 mA:

I ≤ 2 mA

Direct voltage

Range	Error	Resolution
0/2...10 V	≤ 0.1 %	≤ 0.4mV

Input resistance ≥ 50 kΩ

Transmitter-Supply

to energize a 2-wire transmitter

Galvanically isolated, Short-circuit proof,

Output: 22 mA / ≥ 17,5 V

Digital Inputs

Logic Inputs (Terminal A, Sect. 1)

Opto-coupler

Nominal voltage 24 V DC external

Residual ripple: ≤ 5%_{opp}

Current sink (IEC 61131 Type 1)

Logic „0“ = -3...5 V

Logic „1“ = 15...30 V

Current approx. 6 mA

Outputs

Outputs (Terminal P, Sect. 1..4)

Depending on version 4 Relays or 2

Relays and 2 option module slots

Relay outputs

Relays have potential free change-over contacts

Contact rating:

Max. 500 VA, 250 V, 2 A at 48...62 Hz,

cosφ ≥ 0,9

Min. 12 V, 10 mA AC/DC

Switching cycles:

electrical for I = 1A/2A (resistive load)

≥ 800.000 / 500.000 at ~ 250V.

If the relays operate external contactors,

these must be fitted with RC snubber

circuits to prevent excessive switch-off

voltage peaks! Varistor protection is not

recommended!

Modular I/O Extension

Option slots base unit

Option slots (Terminal A, Sect. 2,3)

Option slots for sections A2 and A3 are

providing 4 terminals each and can

support all available option modules.

Option modules are galvanically isolated

from the base unit. Details of available

modules see chapter

„In-/Output Extension Modules“.

Option slots (Terminal P, Sect. 3,4) (optional instead of relays)

Option slots for sections P3 and P4 are

providing 3 terminals each. They support

input modules for standard signals

(0/4...20mA, 0/2...10V) and SSR driver

modules. Dual channel modules share a

common reference terminal. Option

modules are galvanically isolated from the

base unit. Details of available modules see

chapter

„In-/Output Extension Modules“.

Option module carrier board for terminals B, C

Option slots (Terminal B)

Behind terminal strip B an optional module

carrier board with 4 slots can be installed.

All module types are supported. Each

module is galvanically isolated from the

rest of the unit. Details of available

modules see chapter „In-/Output Extension

Modules“.

Option slots (Terminal C)

Same specification as terminal B

Digital In-/Output board for terminals B, C

Control inputs di1...di10

Current sink (IEC 61131 Type 1)

Nominal voltage 24 V DC external

Residual ripple: ≤ 5%_{ss}

Logic „0“ = -3...5 V

Logic „1“ = 15...30 V

Current approx. 6 mA

Control outputs do1...do4

Galvanically isolated opto-coupler outputs.

Grounded load (common positive control

voltage)

Supply voltage 24 V DC external

Residual ripple ≤ 5%_{ss}

Switching capacity: 18...32 VDC; ≤ 70mA
 Internal voltage drop: ≤ 0,7V
 Refresh-Rate: 100 ms
 Protective circuit: thermal against short circuit; Overload cut-off

Limitations to take into account

To avoid inadmissible self-heating the number of output extension modules is limited. This concerns L, B, A and P modules. The following rule applies:

- When using fieldbus option
Max 4 modules per unit.
- When not using fieldbus option
Max 5 modules per unit.

In-/Output Extension Modules

Analog Inputs

U-Module

Universal input module
 No of channels: 1

The technical design corresponds to the universal input of the basic unit

R-Module

RTD module (resistance thermometer)
 No of channels: 2 (with 3- or 4-wire-connection just one).

Type of sensor can be selected separately for each channel!
 Sensor current: ≤ 0,25 mA

Resistance thermometers

Connection: 2-, 3- or 4-wire

Type	Range	Error	Resolution
Pt100	-200...850°C	≤ 1 K	0,071
Pt100	-200...100°C	≤ 0,5 K	0,022
Pt1000	-200...850°C	≤ 1 K	0,071
Pt1000	-200...100°C	≤ 0,5 K	0,022
Ni100	-60...180°C	≤ 1 K	0,039
Ni1000	-60...180°C	≤ 0,5 K	0,039

Linearization: in °C or °F

Lead resistance

Pt (-200...850°C): ≤ 30 Ω per lead

Pt (-200...100°C), Ni: ≤ 10 Ω per lead

Lead resistance compensation:
 not necessary with 3- and 4-wire connection.

For 2-wire connection with short-circuited sensor via the front user interface.

Influence of lead resistance:
 negligible with 3 or 4-wire connection

Input circuit monitoring for break of sensor or lead and short circuit.

Resistance measurement / Potentiometers

2-, 3- or 4-wire connection
 Potentiometer 2-wire connection

Range	Error	Resolution
0...160 Ω	≤ 1%	0,012
0...450 Ω	≤ 1%	0,025
0...1600 Ω	≤ 1%	0,089
0...4500 Ω	≤ 1%	0,025

Characteristic linear

Cable compensation or Calibration (0%/100%) can be carried out via the user interface with sensor connected.

- 0% calibration for 2-wire resistor measurement
- 0% and 100% calibration for potentiometer

Influence of lead resistance:
 negligible with 3 or 4-wire connection.

Input circuit monitoring for break of sensor or lead and short circuit

T-Module

Thermo coupler module (TC, mV, mA)
 No of channels: 2 (Differential input).

Type of sensor can be selected separately for each channel!

Thermocouples

According to DIN IEC 60584
 (not Type L, W(C) und D)

Type	Range	Error	Resolution
L ¹⁾	-200...900°C	≤ 2 K	0,080
J ¹⁾	-200...1200°C	≤ 2 K	0,082
K ¹⁾	-200...1350°C	≤ 2 K	0,114
N ¹⁾	-200...1300°C	≤ 2 K	0,129
S	-50...1760°C	≤ 3 K	0,132
R	-50...1760°C	≤ 3 K	0,117
B ²⁾	0...1820°C	≤ 3 K	0,184
T ¹⁾	-200...400°C	≤ 2 K	0,031
C ³⁾	0...2300°C	≤ 2 K	0,277
D	0...2300°C	≤ 2 K	0,260
E ¹⁾	-200...900°C	≤ 2 K	0,063

¹⁾ accuracy valid from -100 °C

²⁾ accuracy valid from 400 °C

³⁾ C(W) W5Re/W26Re

Linearization in °C or °F

Linearity error: negligible

Input resistance: ≥ 1MΩ

Internal temperature compensation (CJC):

Error: ≤ 0,5K/10K

External JCC possible: 0...60 °C or

32...140 °F

Effect of source resistance: 1mV/kΩ

Sensor monitoring:

Sensor current: ≤ 1μA

Reverse polarity detection triggers at 30K below range min.

mV-Input

Range	Error	Resolution
0...30 mV	≤ 45 μV	1,7 μV
0...100 mV	≤ 150 μV	5,6 μV
0...300 mV	≤ 450 μV	17 μV

Input resistance: ≥ 1MΩ

Sensor break monitoring: built in

Sensor current: ≤ 1μA

mA-Input

Range	Error	Resolution
0/4...20 mA	≤ 0.1 %	≤ 0.8μA

Input resistance: 5 Ω

Sensor alarm: << 2 mA (with 4...20 mA)

Over range alarm: >>22mA

V-Module

High impedance voltage input module

No of channels: 2

Range can be selected separately for each channel!

Range	Error	Resolution
-50...1500 mV	≤ 1,5 mV	0,09mV
0...10 V	≤ 10 mV	0,56mV

Voltage linear characteristic

Input resistance: >>1GΩ

Effect of source resistance: 0,25mV/MΩ

Sensor monitoring: not available

P-Module

Input module with transmitter supply

No of channels: 1

The technical design of the input corresponds to the T-Module

Transmitter-Supply

to energize a 2-wire transmitter or up to 4 opto-coupler inputs.

Galvanically isolated, Short-circuit proof,

Output: 22 mA / ≥ 17,5 V

Analog Outputs

L-Module

Linear output module

No of channels: 2

Resolution: 16 Bit

Refresh-Rate: 100ms

Signal ranges: 0/4...20mA

(configurable by channel)

Resolution: approx. 5 μA/Digit

Error: ≤ 0,2%

Load: ≤ 500 Ω / ≤ 150 Ω (selectable)

Influence of load: ≤ 0,05%/100Ω

Used as logic signal

0 / ≥ 20 mA

B-Module

Bipolar linear output module

No of channels: 2

Resolution: 16 Bit

Refresh-Rate: 100ms

Signal ranges: 0/2...10V, -10...10V

(configurable by channel)

Resolution: approx. 5 mV/Digit

Error: ≤ 0,2%

Load: ≥ 2kΩ

Influence of load: ≤ 0,05%/100Ω

Used as logic signal

0 / ≥ 10 V

Digital In-/Outputs

D-Module

Digital I/O module

No of channels: 2

configurable as input or output per channel

Reverse polarity protection.

Input

Current sink (IEC 61131 Type 1)

Nominal voltage 24 V DC external

Residual ripple: $\leq 5\%_{pp}$

Logic „0“ = $-3...5$ V

Logic „1“ = $15...30$ V

Cycle time: 100 ms

Galvanically isolated

Input resistance: 5 k Ω

Output

Grounded load (common positive control voltage)

Supply voltage 24 V DC external

Residual ripple $\leq 5\%_{ss}$

Switching capacity: 18...32 VDC; ≤ 70 mA

Internal voltage drop: $\leq 1,5$ V

Refresh-Rate: 100 ms

Galvanically isolated

Protective circuit: thermal against short circuit; Overload cut-off

A-Module

SSR driver module

No of channels: 2

Logic „0“: 0V

Logic „1“: ≥ 10 V

Load: $\geq 500\Omega$

Galvanic Separation

Galvanically isolated areas are visualized in the diagram underneath. In general, each of the I/O modules is galvanically isolated from the rest of the unit. Channels inside a module are not separated.

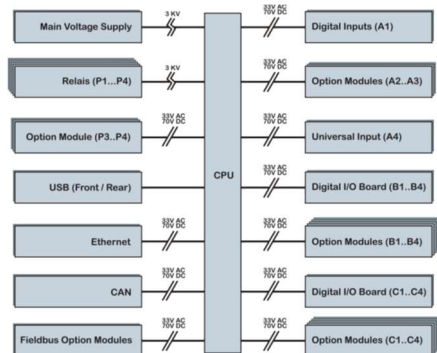

Signal- and measurement circuits

Functional isolation up to a voltage of 33V_{AC}/70V_{DC} against each other and against ground (according EN 61010-1).

Mains circuits 90...250 VAC, 24V DC

Safety isolation up to a voltage of 3kV against each other and against ground

(according EN 61010-1).

Remote I/O-Extension

Detailed technical data and functional descriptions of remote I/O systems can be found in the related documents.

CAN Interface (CANopen)

Transmission speeds:

Com. speed	max. cable length
10 kbit/s	1200 m
20 kbit/s	1000 m
50 kbit/s	1000 m
100 kbit/s	500 m
125 kbit/s	250 m
250 kbit/s	250 m
500 kbit/s	100 m
800 kbit/s	50 m
1000 kbit/s	25 m

Termination resistor

Internal resistor connectable by switch

Transmission mode:

cyclic

Error detection:

Automatic node monitoring

(“node guarding“).

Addressing:

KS 98-X: 1...24 (Default =1)

RM 200: 2...42 (Default =32)

Refresh times:

Depending on the selected transmission speed and the number of CAN-nodes connected.

- RM 200: typical 100ms
- Cross communication: ≥ 200 ms

Maximum Setup RM 200

≤ 16 Analog Inputs and ≤ 16 Analog

Outputs per RM200-Rack!

Digital I/O is only limited by the size of the rack

Examples: 72 digital In- /Outputs (without analog modules!), or 16 analog Inputs plus 16 analog Outputs plus 8 digital In- /Outputs.

Engineering Tools

KS98-2 units can be programmed and maintained with the following tools:

ET/KS98: from Version 7.0

SIM/KS98-2: from Version 1.0

Front Interface (Standard)

The front accessible USB interface uses a standard USB cable.

It provides access for the programming and diagnosis tool ET/KS98-2 even with the unit not connected to power.

Fieldbus Interfaces (Optional)

RS 485 Module

Galvanically isolated RS 485 interface (Protocol: Modbus or ISO1745)

PROFIBUS-DP Module

According to EN 50170 Vol. 2

Read/write access to process values parameters and configuration data.

Configurable process data modules

Data content for cyclic transfer of process values can be assigned within the user program.

The parameter channel provides non-cyclical access to other parameters and configuration data.

Data format

Values are transmitted using the IEEE-format (REAL) or a 16-Bit-fixpoint notation (FIX) with one decimal digit (configurable).

Transmission speeds and cable lengths

Automatic speed detection

Speed	max. cable length
9,6 kbit/s	1200 m
187,5 kbit/s	1000 m
500 kbit/s	400 m
1,5 Mbit/s	200 m
12 Mbit/s	100 m

Addresses

0...126 (Factory setting: 126)

Remote addressing supported.

Other functions

Sync and Freeze

Connection

9pin. Sub-D connector

Termination resistor

Internal with switch

PROFINET-IO Module

KS98-2 provides as a Profinet-IO Device access to process data and parameters.

Integrated Switch

An integrated Switch allows to easily wire the network in a line structure.

Selectable process data

Data provided for the cyclic data exchange can be defined by the user program.

Data format

Values are transmitted using the IEEE-format (REAL) or a 16-Bit-fixpoint notation (FIX) with one decimal digit.

Display

3,5" color TFT display with LED backlight

Resolution: 320 x 240 (QVGA)

Capacitive Touch

Dimensions

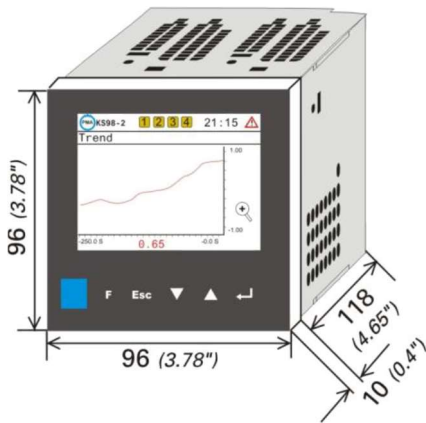

Power Supply

depending on order code:

Mains Supply

100-240VAC (+10%-10%) / 48...62 Hz
Power consumption: approx. 38 VA
(fully equipped)

Low voltage supply 24 V DC

24VDC (+25%-20%)
Power consumption: approx. 17W
(fully equipped)

Behavior with power failure

User program, configuration, parameter and active setpoints

Are permanently stored in EEPROM

Working data of functions

(Programmer, Integrator, Counters, ...
Stored in a capacitor buffered RAM
(typically >> 15 Minutes).

Real Time Clock

Backed up with a Lithium battery.

Environmental Conditions

Protection

Front: IP 65
Housing: IP 20
Terminals: IP 00
according DIN EN 60529 (VDE 0470-1)

Ambient Temperature range

Operation: 0...55 °C
Storage/Transport: -20...60 °C
Humidity: ≤ 75% RH yearly average,
non-condensing

Temperature influence

Reference temperature 25°C
Temperature influence << 0.05 %/ 10 K

Shock and vibration

Vibration test according to
DIN EN 60068-2-6
Frequency: 10...150 Hz
Unit in operation: 1 g / 0,075 mm,

Unit not in operation.: 2 g / 0,15 mm

Shock test according to
DIN EN 60068-2-27
Shock: 15 g
Duration 11 ms

Electromagnetic Compatibility

Complies with EN 61326-1
"continuous, non-monitored operation"

Safety

According EN 61010-1

- Overvoltage category II
- Contamination class 2
- Working voltage range 300 V
- Protection class II

General

Housing

Plug-in unit, inserted from the front
Material: Makrolon 9415, flame retardant,
self-extinguishing
Flammability class:: UL 94 VO

Weight

approx. 750 g (fully equipped)

Mounting

Panel mounting with 2 fixing elements at
top and bottom.
Close mounting possible
Orientation as desired

Electrical connections

depending on order code:

- Screw terminals for conductor cross-section 0,5 - 2,5 mm²
- Flat pin connectors 1 x 6,3mm or 2 x 2,8mm according DIN 46244

CE Compliance

Meets the European Directives regarding
„Electromagnetic Compatibility“ and „Low-voltage equipment“

UL & cUL Compliance

(Type 1, indoor use)
File: E 208286
For compliance with UL certificate, the
following information must be considered:

- Use only Screw Terminal variant
- Use only 60/75°C copper (Cu) conductors.
- Tighten the terminal-screws with a torque of 0.5 – 0.6 Nm.
- The instrument shall be mounted on a flat surface of a "Type 1 Enclosure" for "Indoor use" only.
- Ambient temperature: ≤ 50 °C
- Power supply: ≤ 250 VAC
- Max. ratings of relay contacts:
250 VAC, 2 A, 500 W (resistive)
250 VAC, 2 A, 360 VA (inductive)

In the box

- Device according to order code
- Concise manual (DE/EN/FR)
- 4 fixing clamps

Accessoires & Software

Engineering Tool ET/KS98-2

Graphical function block editor for programming and maintenance of KS98-2 units

Simulation SIM/KS98-2

Program to simulate KS 98-2 on a PC screen with full functionality of the device plus:

- Simulation of In- and Outputs
- Trend diagrams
- „Turbo“-Mode (time laps)

USB-Cable

To connect PC with programming utility to the unit.
(KS 98-2 Front USB Interface)

Delivered Condition

Upon delivery, every unit contains a simple demo program showing the basic function of the instrument. It needs to be replaced by a proper user program before installation.

Rear Terminal Connections

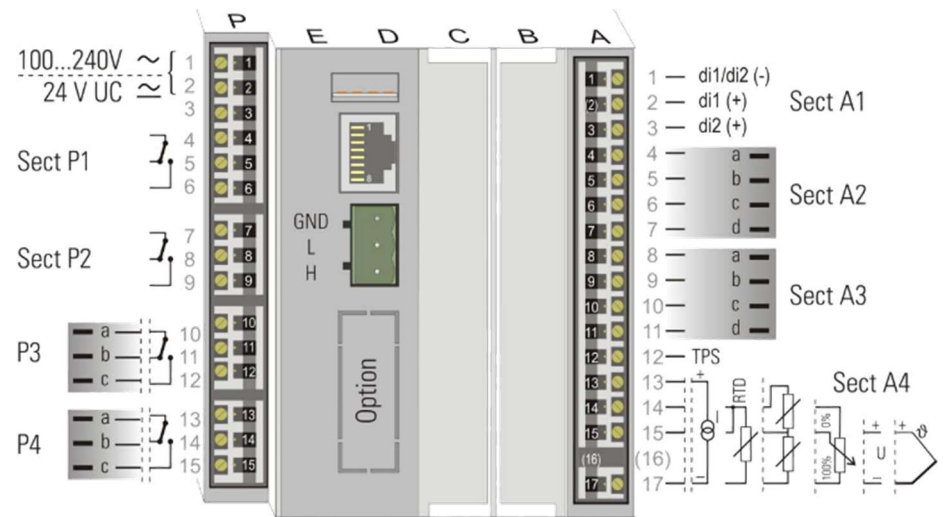

Standard Interfaces



Optional Interfaces

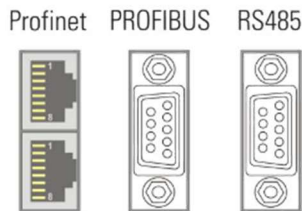

Module carrier (B/C) Digital module (B/C)

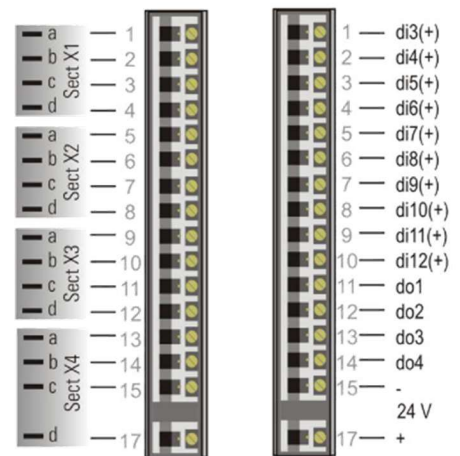

KS98-2 Base units

	KS98	-	2	x	x	-	x	x	x	x	x	-	x	0	0
Base Models															
Universal Input, 2 digital Inputs, TPS, RTC with Fast-On Terminals				0											
with Screw Terminals				1											
Power Supply & Outputs [P]															
90...250V (2 Relays, 2 option module slots)														0	
24V DC (2 Relays, 2 Option Slots)														1	
90...250V (4 Relays)														2	
24V DC (4 Relays)														3	
Communication Options [D]															
none / for stand-alone applications															0
Standard Interfaces (Ethernet, USB and CAN for Remote I/O)															1
Standard Interfaces plus RS485 / Modbus															2
Standard Interfaces plus Profibus															3
Standard Interfaces plus Profinet															4
Options															
none															0
Datalogger															1
I/O Extensions [B]															
not fitted															0
Digital-I/O Extension (10 DI, 4 DO)															1
Modular Extension (4 option module slots)															2
I/O Extensions [C]															
not fitted															0
Digital-I/O Extension (10 DI, 4 DO)															1
Modular Extension (4 option module slots)															2
Configuration															
Default settings; No option modules installed															0
Default settings; Option modules according to additional order line															1
Preset to specification; No option modules installed															8
Preset to specification; Option modules according to additional order line															9
Certification															
Standard (CE certified)															0
UL / cUL certified															U

Extended order code for factory installed option modules:

Position of digit within the order code defines the positioning of the module and assignment to output terminals
Positions at terminal strips B and C require extension cards

Strip P, Segment 3
Strip P, Segment 4
Strip A, Segment 2
Strip A, Segment 3
Strip B, Segment 1
Strip B, Segment 2
Strip B, Segment 3
Strip B, Segment 4
Strip C, Segment 1
Strip C, Segment 2
Strip C, Segment 3
Strip C, Segment 4

A98 - F - x x x x x x x x x x x x x x

Modules and possible positions	0	0	0	0	0	0	0	0	0	0	0	0	0	0	0
not fitted	0	0	0	0	0	0	0	0	0	0	0	0	0	0	0
Universal Input	-	-	U	U	U	U	U	U	U	U	U	U	U	U	U
Dual Pt100/1000, Ni100/1000, Resistance	-	-	R	R	R	R	R	R	R	R	R	R	R	R	R
Dual Thermocouple, mV, 0/4...20mA	-	-	T	T	T	T	T	T	T	T	T	T	T	T	T
Dual -50...1500mV (eg. Zirconia probe), 0...10V	-	-	V	V	V	V	V	V	V	V	V	V	V	V	V
0/4...20mA Input with transmitter power supply	-	-	P	P	P	P	P	P	P	P	P	P	P	P	P
Dual DC Drive Output for SSR	A	A	A	A	A	A	A	A	A	A	A	A	A	A	A
Dual Linear Out (0/4...20mA)	L	L	L	L	L	L	L	L	L	L	L	L	L	L	L
Dual bipolar Linear Out (-10V...10V)	B	B	B	B	B	B	B	B	B	B	B	B	B	B	B
Dual Digital I/O	-	-	D	D	D	D	D	D	D	D	D	D	D	D	D

Separate module orders:

A98 - M - x

Available modules	U	R	T	V	P	A	L	B	D
Universal Input	U								
Dual Pt100/1000, Ni100/1000, Resistance		R							
Dual Thermocouple, mV, 0/4...20mA			T						
Dual -50...1500mV (eg. Zirconia probe), 0...10V				V					
0/4...20mA Input with transmitter power supply					P				
Dual DC Drive Output for SSR						A			
Dual Linear Out (0/4...20mA)							L		
Dual bipolar Linear Out (-10V...10V)								B	
Dual Digital I/O									D

Contact



E-Mail: enquiries@west-cs.com

Website: www.west-cs.co.uk



Address: The Hyde Business Park
Brighton, East Sussex
BN2 4JU
United Kingdom



Telephone: +44 (0)1273 606271

Fax: +44 (0)1273 609990